

IEC Appliance Inlet C14 with Filter, Line Switch 1-pole



C14

 70° C



Description

- Panel Mount:
Screw-on mounting from front side
- 3 Functions:
Appliance Inlet Protection class I, Line Switch 1-pole, Line-filter in standard version
- Quick connect terminals 6.3 x 0.8 mm

Approvals

- VDE Certificate Number: 40004665 (FKS)
- UL File Number: E72928 (FKS)

Characteristics

- All single elements are already wired
- Line switch non-illuminated
- With EMC-shield
- Qualified for use in equipment according IEC/EN 60950

References

Alternative: version without line filter [KEB1](#)
 We recommend for new applications the new type [DC12](#)

Weblinks

[pdf](#), [html](#), [General Product Information](#), [Approvals](#), [RoHS](#), [CHINA-RoHS](#), [Mating Connectors](#), [e-Shop](#), [SCHURTER-Stock-Check](#), [Distributor-Stock-Check](#), [Accessories](#)

Technical Data

Ratings IEC	1 - 10A @ Ta 40 °C / 250 VAC; 50Hz
Ratings UL/CSA	1 - 10A @ Ta 40 °C / 125 VAC; 60Hz
Leakage Current	standard < 0.5 mA (250V / 60Hz)
Dielectric Strength	> 1.7 kVDC between L-N > 2.7 kVDC between L/N-PE Test voltage (2 sec)
Allowable Operation Temp.	-25 °C to 85 °C
Climatic Category	25/085/21 acc. to IEC 60068-1
Degree of Protection	from front side IP 40 acc. to IEC 60529
Protection Class	Suitable for appliances with protection class 1 acc. to IEC 61140
Terminal	Quick connect terminals 6.3 x 0.8 mm
Panel Thickness s	Screw: max 8 mm Mounting screw torque max 0.5 Nm
Material: Housing	Thermoplastic, black, UL 94V-0

Appliance-Inlet/-Outlet	C14 acc. to IEC/EN 60320-1, UL 498, CSA C22.2 no. 42 (for cold conditions) pin-temperature 70 °C, 10A, Protection Class 1
Line Switch	Rocker switch 1-pole, non-illuminated, acc. to IEC 61058-1 Technical details
Line Filter	Standard Version, IEC 60939, IEC 60601-1, UL 1283, UL 544, EN 133 200, CSA C22.2 no. 8 Technical details
MTBF	> 2'100'000 h acc. to MIL-HB-217 F

Dimensions

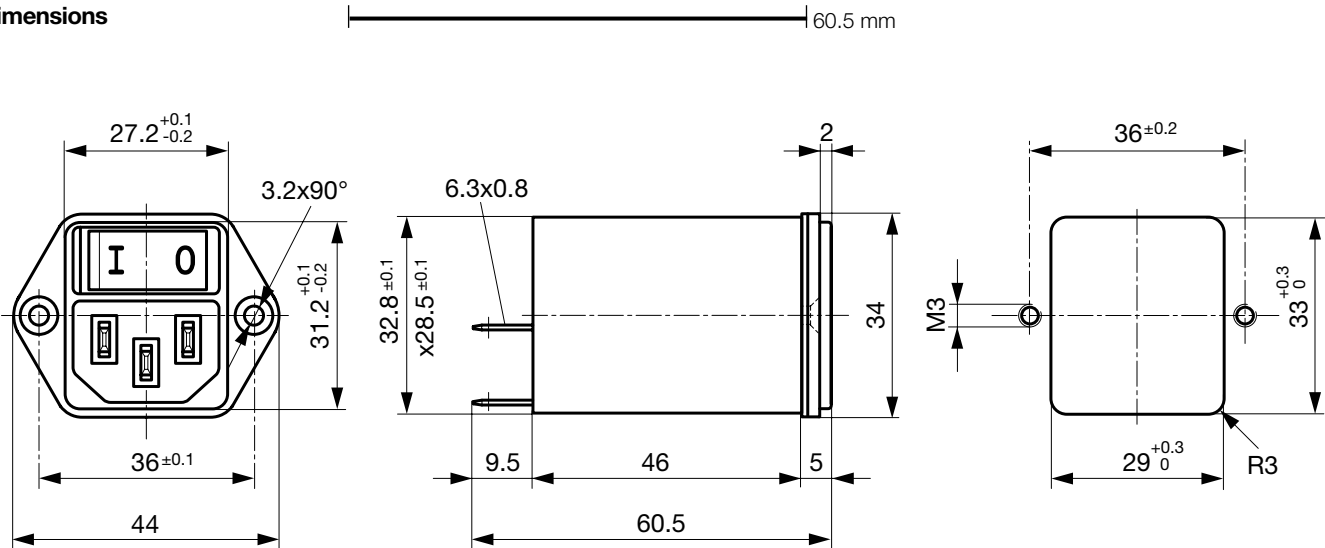

Technical Data of Filter-Components

Rated Current [A]	Filter-Type	Inductances L [mH]	Capacitance CX [nF]	Capacitance CY [nF]
1	Standard Version	2 x 10	68	2.2
2	Standard Version	2 x 4	68	2.2
4	Standard Version	2 x 1.5	68	2.2
6	Standard Version	2 x 0.8	68	2.2
10	Standard Version	2 x 0.3	68	2.2

Diagrams

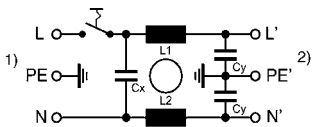

- 1) Line
- 2) Load

Attenuation Loss

Standard version

--- differential mode ____ common mode

1 A

2 A

4 A

6 A

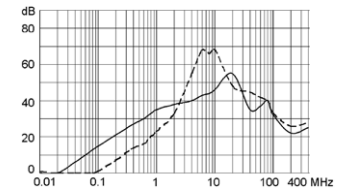
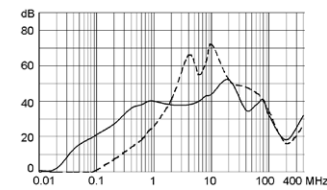
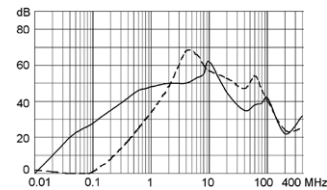
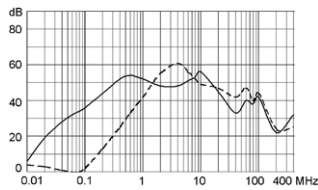

10 A

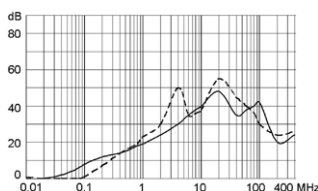

Variants

Rated Current [A]	Filter-Type	Order Number
1	Standard Version	4302.5001
2	Standard Version	4302.5002
4	Standard Version	4302.5003
6	Standard Version	4302.5004
10	Standard Version	4302.5005

Packaging unit 10 Pcs

Accessories

Description



Assorted Covers
Rear Cover



Cord retaining kits
Cord retaining strain relief

Mating Outlets/Connectors

Category / Description

[Appliance Outlet Overview complete](#)



IEC Appliance Outlet F, Screw-on Mounting, Front Side, Solder Terminal	4787
IEC Appliance Outlet F, Snap-in Mounting, Front Side, Solder or Quick-connect Terminal	4788
IEC Appliance Outlet F or H, Screw-on Mounting, Front Side, Solder, PCB or Quick-connect Terminal	5091
IEC Appliance Outlet F or H, Screw-on Mounting, Front Side, Solder or Quick-connect Terminal	5092

[Appliance Outlet further types to KFB1](#)

[Connector Overview complete](#)



IEC Connector C15, Rewireable, Straight	0101
IEC Connector C15A, Rewireable, Straight	0102
IEC Connector C15A, Rewireable, Straight	0102-G
IEC Connector C15A, Rewireable, Angled	0112
IEC Connector C13, Rewireable, Angled	4012

[Connector further types to KFB1](#)

[Power Cord Overview complete](#)



Power Cord with IEC Connector C13, Angled	0311
Power Cord with IEC Connector C13, Angled	3011
Power Cord with IEC Connector C13, Angled	3012
Power Cord with IEC Connector C13, Angled	3013
Power Cord with IEC Connector C13	3020

[Power Cord further types to KFB1](#)